

# Zero Shapes\_

XM034\_.552 - XM034\_.553 - XM034\_.554

**XM034\_.552.0002**

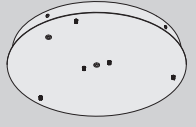

**XM034\_.553.0002**

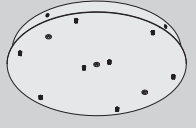

**XM034\_.554.0002**

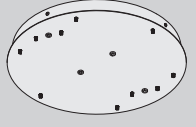

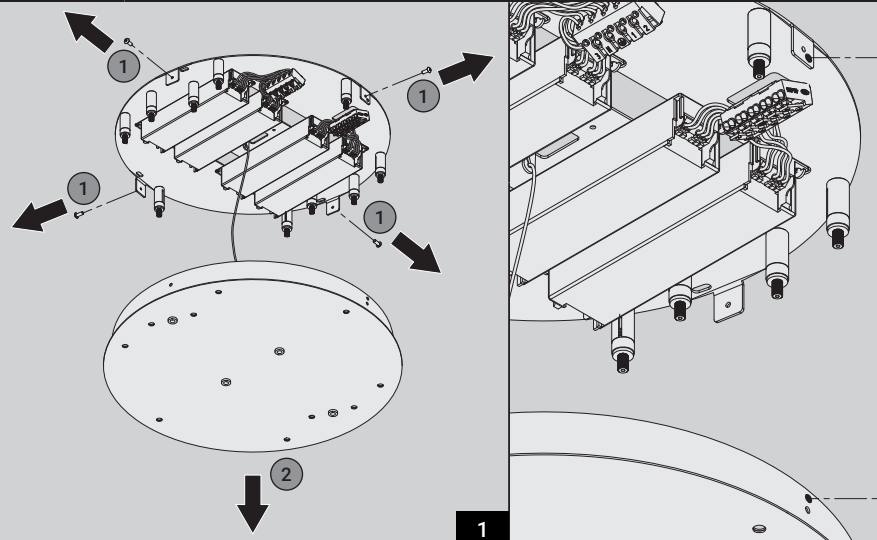

**x = 247mm**  
**x = 9<sup>3</sup>/<sub>4</sub> in**

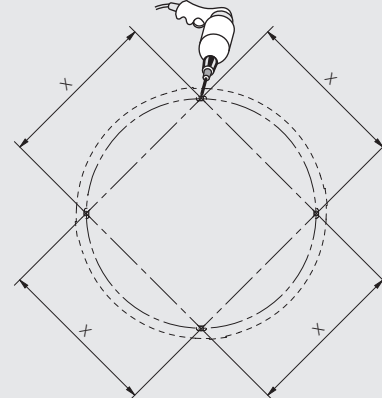

Dima per fori  
Template for holes  
Bohrschablone  
Gabarit pour les trous

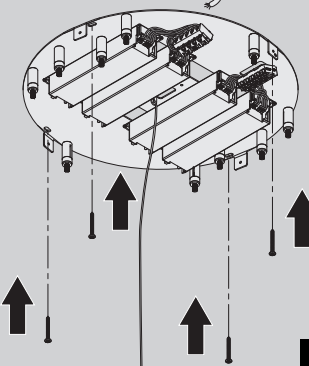

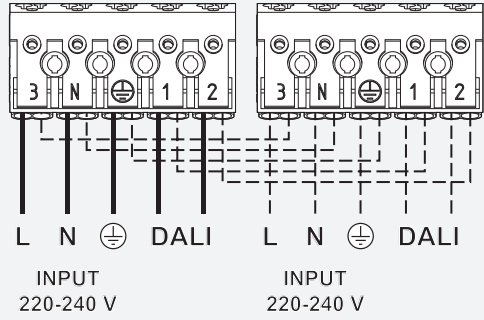

**Collegamento DALI**

Connection DALI

Anschluß-schei DALI

Schema de connexion DALI

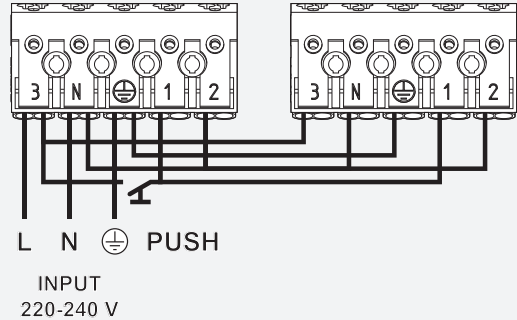

**Collegamento PUSH DIM - ACCENSIONE UNICA**

Connection PUSH DIM - SINGLE SWITCH

Anschluß-schei PUSH DIM - EINMALIGE EINSCHALTUNG

Schema de connexion PUSH DIM - SEUL ALLUMAGE

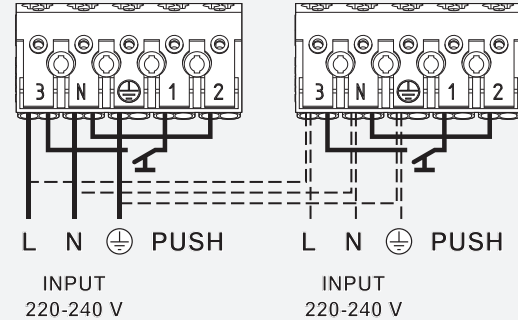

**Collegamento PUSH DIM - DOPPIA ACCENSIONE**

Connection PUSH DIM - DOUBLE SWITCH

Anschluß-schei PUSH DIM - DOPPELTE EINSCHALTUNG

Schema de connexion PUSH DIM - DOUBLE ALLUMAGE

XM034\_\_552.0002

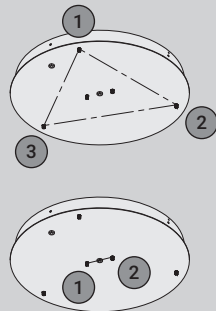

x1 ZERO ELLIPSE  
or  
x1 ZERO ROUND  
or  
x1 ZERO SQUARE

x1 ZERO ROUND  
VERTICAL

7a

XM034\_\_553.0002

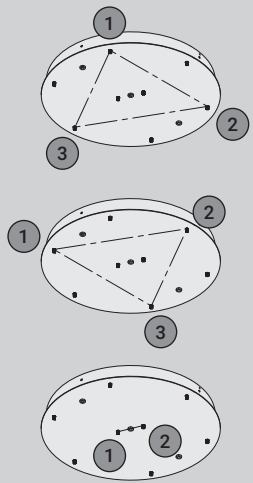

x1 ZERO ELLIPSE  
or  
x1 ZERO ROUND  
or  
x1 ZERO SQUARE

x1 ZERO ELLIPSE  
or  
x1 ZERO ROUND  
or  
x1 ZERO SQUARE

x1 ZERO ROUND  
VERTICAL

7b

XM034\_\_554.0002

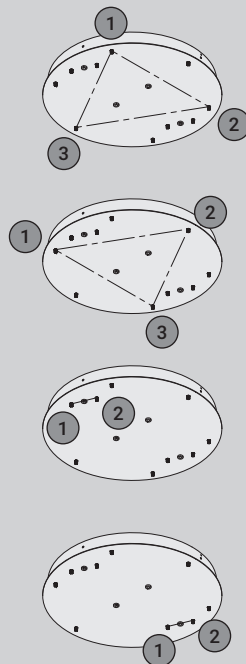

x1 ZERO ELLIPSE  
or  
x1 ZERO ROUND  
or  
x1 ZERO SQUARE

x1 ZERO ELLIPSE  
or  
x1 ZERO ROUND  
or  
x1 ZERO SQUARE

x1 ZERO ROUND  
VERTICAL

x1 ZERO ROUND  
VERTICAL

7c

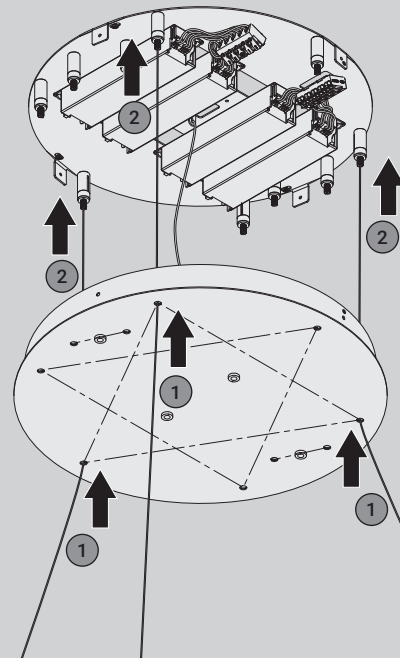

8

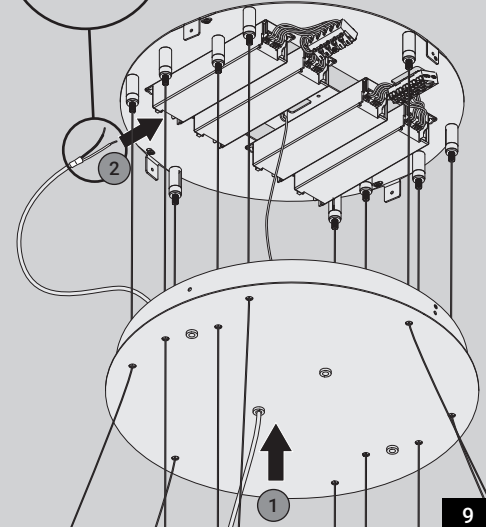
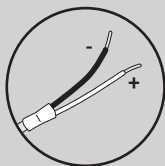

9

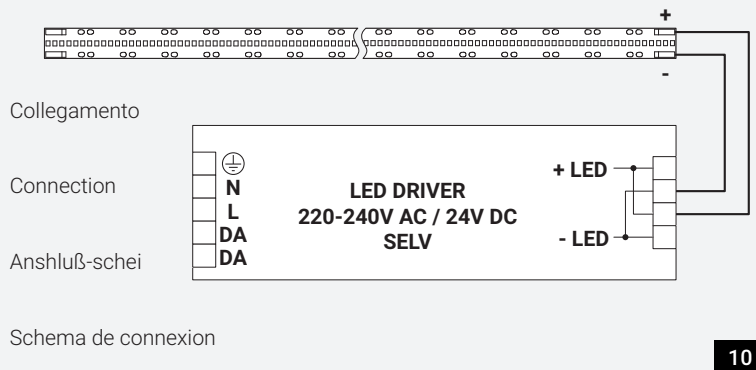

10

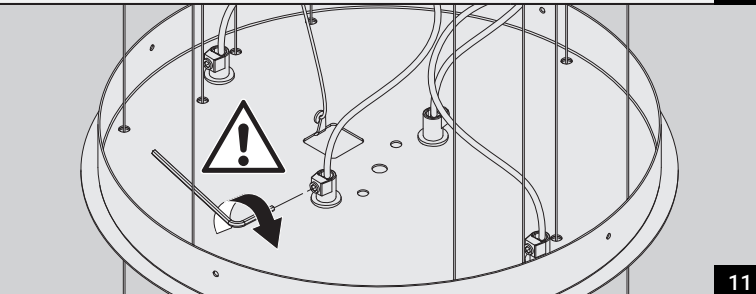

11

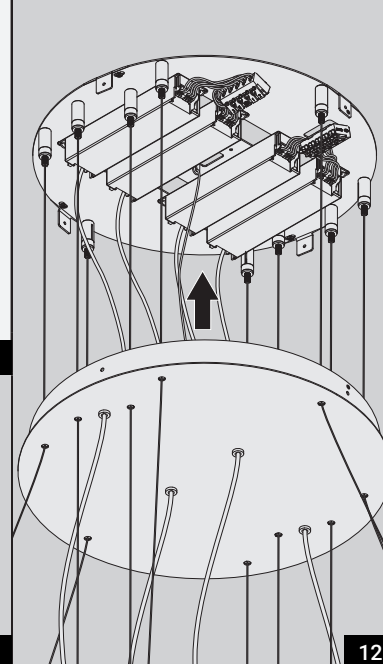

12

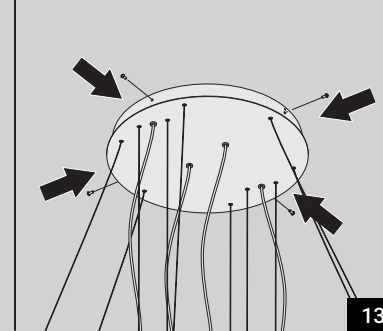

13

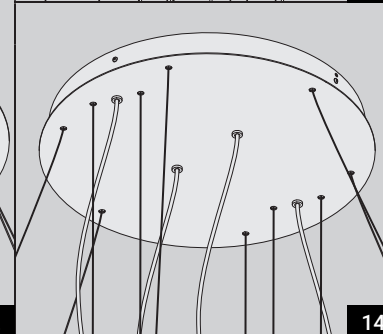

14